



**OX Engineered Products**  
22260 Haggerty Road Suite 365  
Northville, MI 48167  
p. 1.800.345.8881  
f. 248.289.9955  
oxep.com



# OX-IS™

Structural Insulation

## Installation Guide

OX-IS is the all in one product that allows you to meet building code requirements for structural sheathing, continuous insulation, weather and air resistive barrier performance.

Made in USA 

---

### Structural Support

Structural lateral bracing and transverse wind load resistance.

### Water Barrier

Code-approved water resistive barrier.

### Air Barrier

Best in class air barrier performance.

### Insulation

Best-in-class R-value per inch.

---

## CONTENTS

|    |                                    |    |                                 |
|----|------------------------------------|----|---------------------------------|
| 02 | General Notes, Guidelines, Storage | 06 | Door Installation               |
| 03 | OX-IS Installation Overview        | 07 | Window Installation             |
| 04 | Panel Orientation / Fastening      | 08 | Exterior Cladding Installation  |
| 05 | Taping                             | 09 | Vents and Openings Installation |

---

### Attention:

This installation guide is intended to provide general information for the end user. The following guidelines will help you properly install OX-IS<sup>TM</sup>. We encourage you to read these guidelines in order to minimize any risk of safety hazards and to prevent voiding any applicable warranties. This manual is a general installation guide and does not cover every installation situation. Customer is responsible for complying with all applicable laws, regulations, and building codes (collectively, "Laws") of the location where any products (individually, "Product" and collectively, "Products") manufactured by Ox Engineered Products, LLC ("Ox") are actually used, specially including, but not limited to, Laws regarding use and disposal of the Products by Customer. Ox expressly disclaims all liability for the Products other than as expressly provided in the applicable warranty for the Product (the "Product Warranty") which is available from Ox at the address below. OX EXPRESSLY DISCLAIMS ANY OTHER WARRANTY EXPRESSED OR IMPLIED INCLUDING SPECIFICALLY, BUT NOT LIMITED TO, ANY WARRANTY OF MERCHANTABILITY OR FITNESS FOR A PARTICULAR PURPOSE. None of the information contained in this brochure shall act as a waiver of any patent, trademark, copyright or other intellectual property right of Ox, nor shall any such information expand any rights or remedies set forth in the applicable Product Warranty. Ox shall not be liable for compliance of the Products with any test results obtained by third parties that may be included in this brochure. Actual results may vary. Not all Products are approved for use in all jurisdictions. The Products are not load bearing. Do not attempt to walk on them. Some Ox Products are amiable. Ox disclaims liability for damages caused by incineration of the Products. By purchasing the Products, Customer irrevocably consents that any dispute arising between Ox and Customer will be determined

under Michigan law without consideration of any of law analysis and that any such dispute shall be brought only in the state or federal courts serving the locality in which Ox's headquarters are then located. By purchasing the Products, Customer expressly consents to the exercise by such courts of personal and subject matter jurisdiction and venue for such purposes.

### Ox Engineered Products offices:

22260 Haggerty Road, Suite 365,  
Northville, Michigan 48167.  
Phone (800)345-8881

### Storage:

Maintain packaging protection until using the product. If stored exposed without protective packaging, cover with a waterproof tarpaulin. Do not store directly on the ground unprotected or in standing water. Normal care should be taken to avoid excessive moisture exposure (soaking) to unpackaged product.

### Safety Guidelines:

- Follow all OSHA regulations and any other safety guidelines and safety practices.
- Use approved safety belts and/or harnesses or other fall protection equipment

# 03 | Installation Overview

## Overview

The IS System shall be defined to be OX-IS™ Structural Insulation (ASTM E84 Class B), OX 2 7/8" Seam and Ox Arctic Flashing Tapes and OX ISO RED CI®. In addition to being subject to the other limitations contained in this warranty, the water and air barrier warranties are expressly contingent upon the use of only IS System component products. The use of any sheathing other than OX-IS™ Structural Insulation or OX ISO RED CI® or any seam and flashing tapes other than OX Seam and Ox Arctic Flash Synthetic Flashing Tapes shall render the air and water barrier warranties entirely inapplicable and/or null and void.

## Structural Prep

Install any necessary mechanical strapping directly to framing.

- It is recommended that any metal straps, ties or other connectors designed to resist uplift, shear or diaphragm loading must be installed prior to OX-IS Structural Insulation.
- The requirement for mechanical uplift connections shall be determined by the responsible parties.
- Detail A should not be considered typical and only applies when mechanical uplift connections are required.

**TIP:** Straps, ties and connectors installed on the exterior face of the stud will not be visible after the OX-IS Structural Insulation panels are installed. Schedule necessary inspections accordingly.

## Detail A

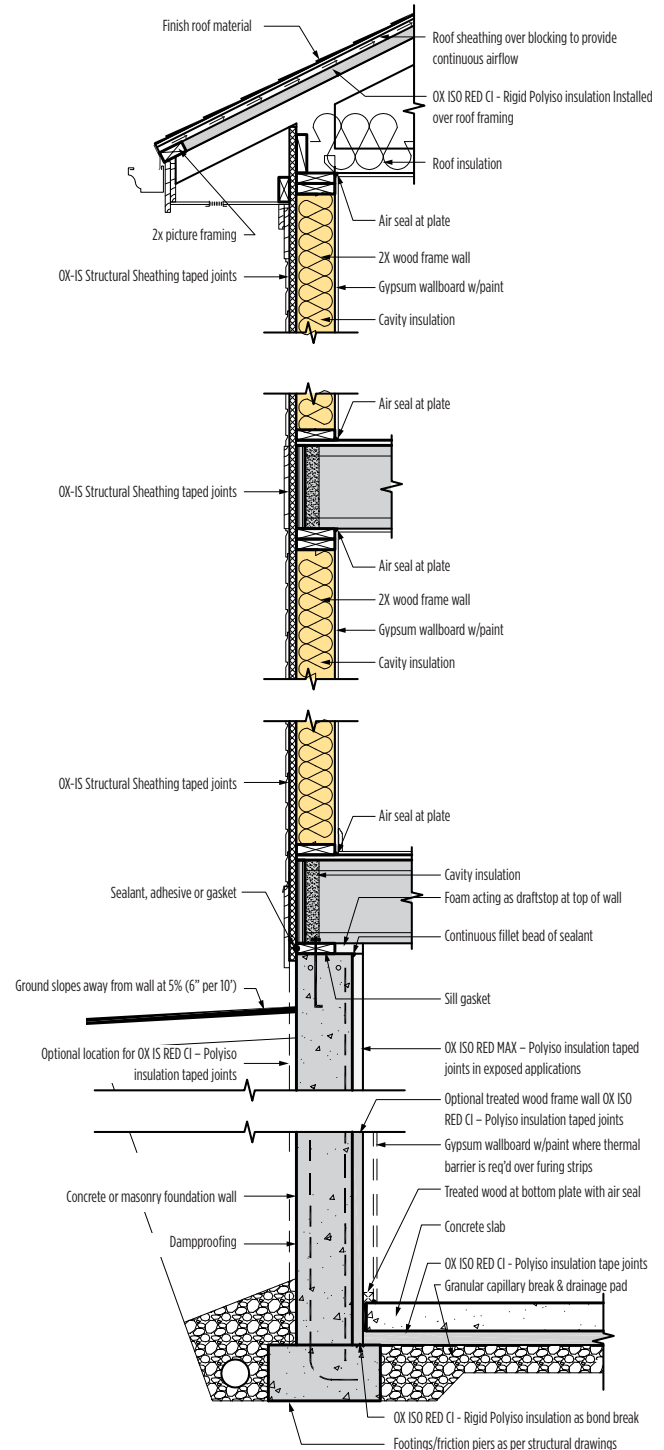

## 04 | Panel Orientation/Fastening

### Orient Panels

- Install OX-IS Structural Insulation panels with the printed foam side facing out
- The panels may be installed with the long side of the panels oriented either horizontally or vertically to the framing members
- All panel edges/seams must be fastened and backed by framing
- Panels should be installed with foam edges touching
- Cut panels with standard circular saw

### Orient Panels (combined w/standard foam sheathing)

- Use OX-IS Structural Insulation in areas where bracing is required
- Supplement remaining wall with nonstructural foam sheathing such as OX ISO RED CI Polyiso Foam Sheathing

Detail B

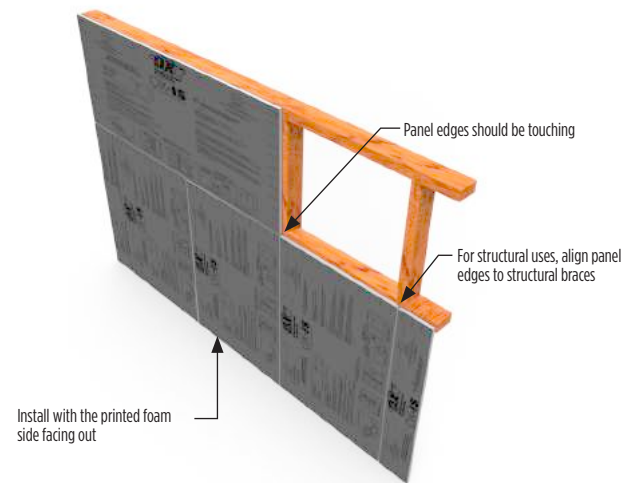

### Fasten Panels

- **Wood studs:** Around perimeter and in the field of the board, fasten OX-IS every 3-inches. Minimum embedment of 1-inch into framing. Counter sinking into foam is acceptable:
  - 7/16-inch to 1-inch crown, 16 gauge staple
  - 0.113-inch (min) diameter nail (roofing nail)
- **Metal studs:** No. 8-18 × 1-1/4 Phillips modified truss head self-drilling screws
- Due to the self-healing characteristics of the Polyiso foam used in this product, it is not required to tape over any of the attachments. Tape is only required at the seams and for larger penetrations in the board.

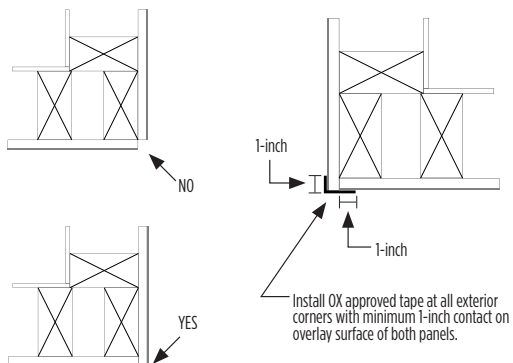

Detail C

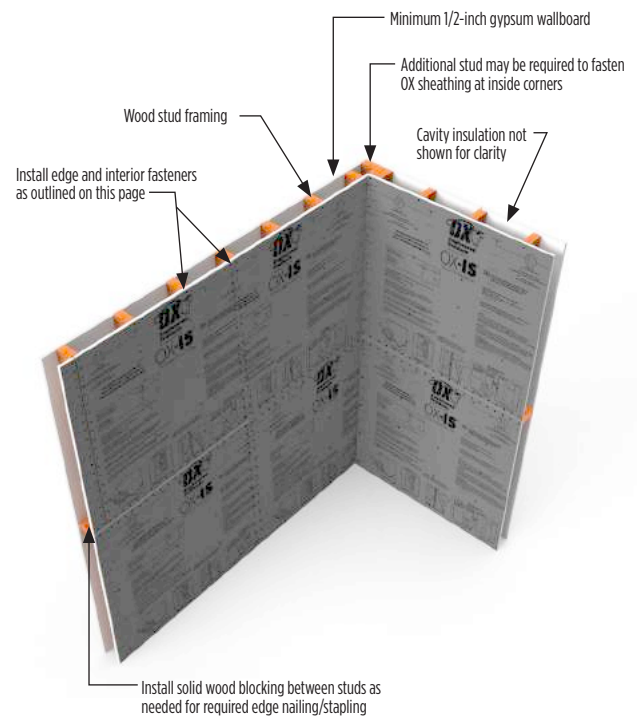

# 05 | Panel Taping

## Taping

- Install tape per manufacturer’s instructions on a clean/dry surface
- Center the tape over the joints/seams
- Apply pressure to the tape to ensure a secure bond. Smooth out any wrinkles to insure proper adhesion.
- When taping joints, use shingle fashion technique as shown in Detail E
- At T-joints, the tape pieces should overlap by at least 1-inch as shown in Detail F
- The warranty requires that all interior and exterior corners be taped using Arctic Flash flashing tape to fully cover the joints/seams as shown in Detail F and Detail G
- Building wrap is not required to meet WRB requirements if all joints are taped
- **Use only OX approved (or equivalents) tapes:**
  - **Seam tape:** OX Seam Tape  
2 1/2-inch nominal width
  - **Flashing tape:** OX Arctic Flash Synthetic Flashing
    - 6-inches at all penetrations
    - 4-inches at interior and exterior corners

Detail D

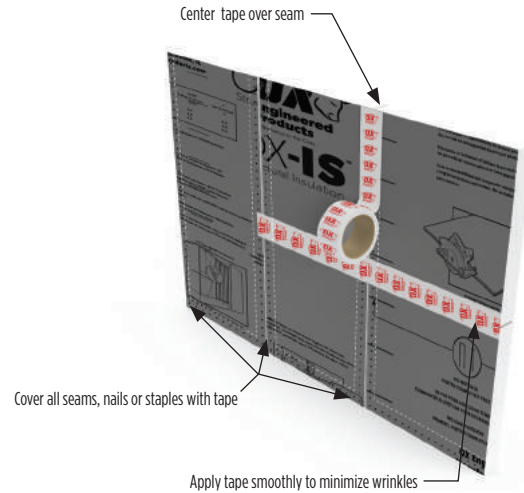

Detail E - Shingle fashion technique

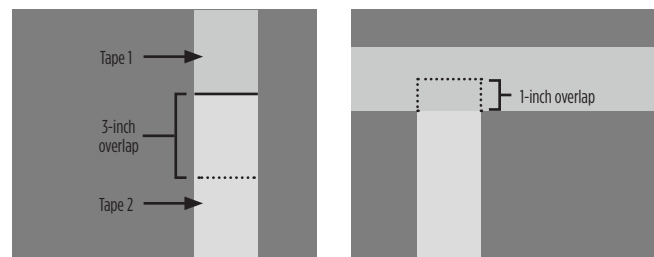

Detail F - Interior corner flashing tape



Detail G- Exterior corner flashing tape

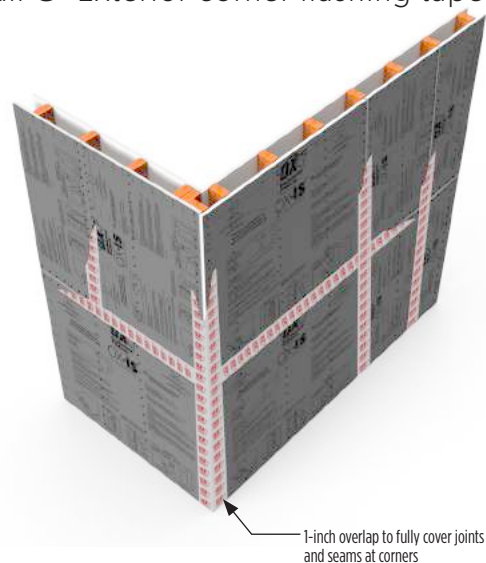



# 06 | Window Installation

## Window Installation

- Install approved OX sill/pan flashing as shown in Detail E on a clean/dry surface
- Apply sealant around inside face of window mounting flange. If needed, gap sealant at the bottom flange to permit drainage. Install and level window per manufacturer's instructions.
- Cut two pieces of approved OX Arctic Flash flashing tape and apply each to the window jamb flanges. Be sure the jamb flashings overlap the sill flashing.
- Cut a length of approved OX Arctic Flash flashing tape and apply to the head flange on the window. Be sure the head flashing overlaps the jamb flashing.
- Apply pressure to the tape to ensure a secure bond and smooth out any wrinkles to insure proper adhesion
- From the interior of the rough opening, apply low-pressure polyurethane foam for windows between the rough opening and the window frame.
- **DO NOT TAPE BOTTOM WINDOW FLANGE**

Detail H

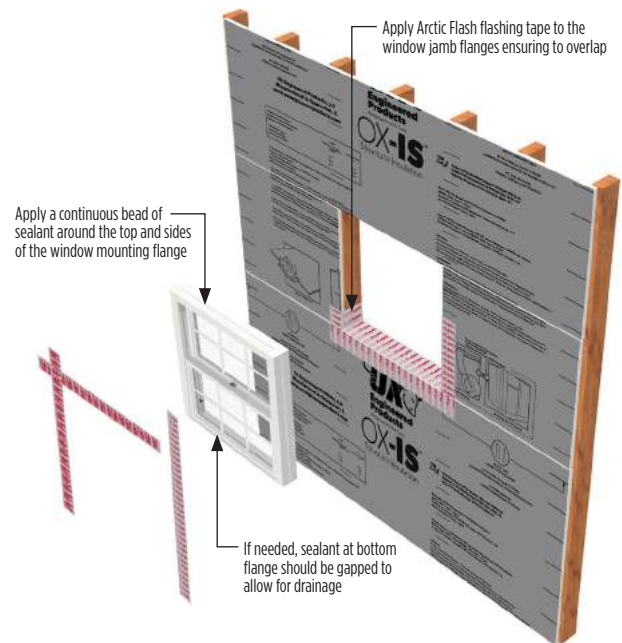

Detail I - Completed installation



# 07 | Door Installation

## Brick Mould Door Installation

- Install approved OX Arctic Flash Flashing tape in jambs of the rough opening as shown in Detail I on a clean/dry surface
- Apply three separate beads of sealant in the threshold and a minimum of 6-inches up the jambs
- Once the door has been installed into the rough opening in accordance with the manufacturer's installation instructions, apply a bead of sealant at the molding/tape intersection
- Install head flashing above door and then tape top of head flashing with OX Seam Tape

Detail J

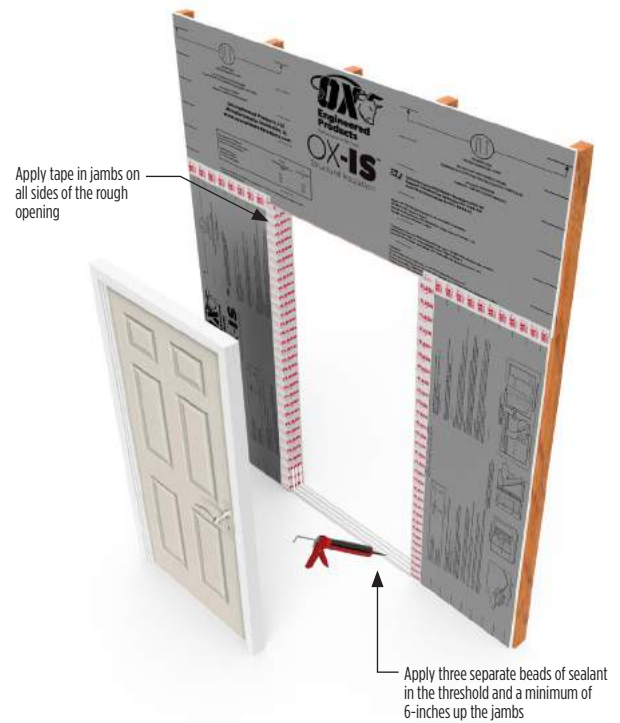

Detail K

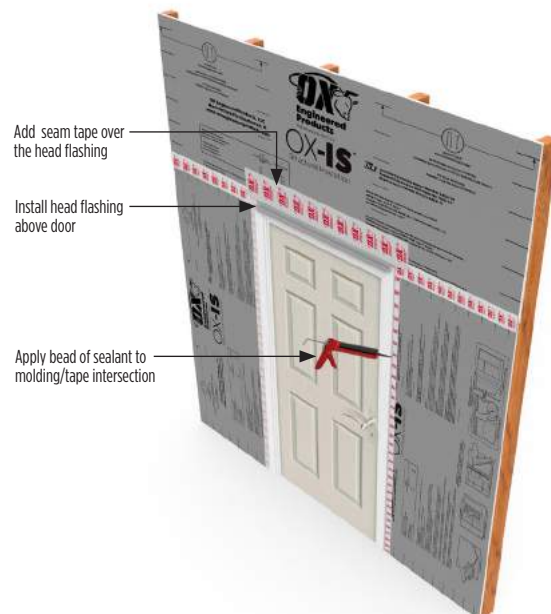

# 08 | Exterior Cladding Installation

## Lap Siding

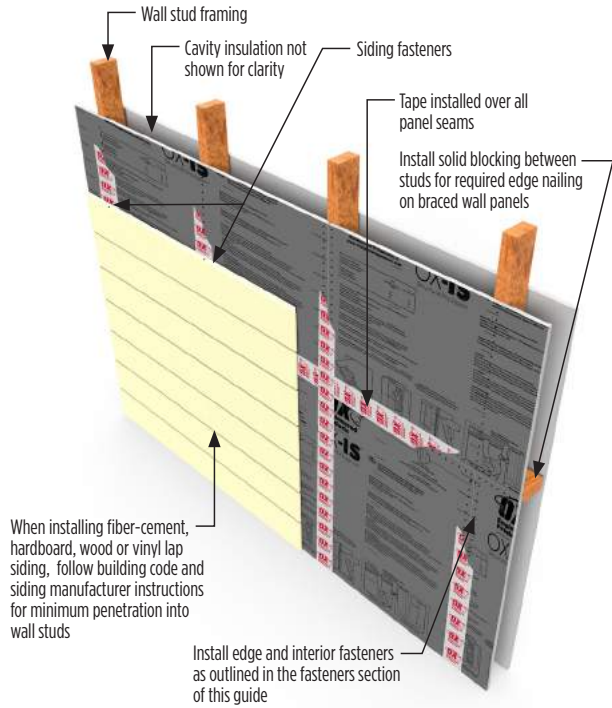

## Anchored Masonry Brick Veneer

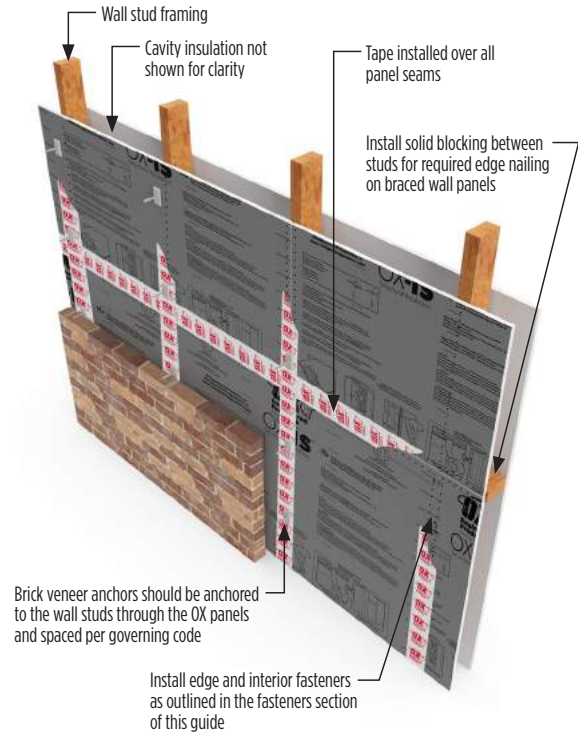

## Stucco

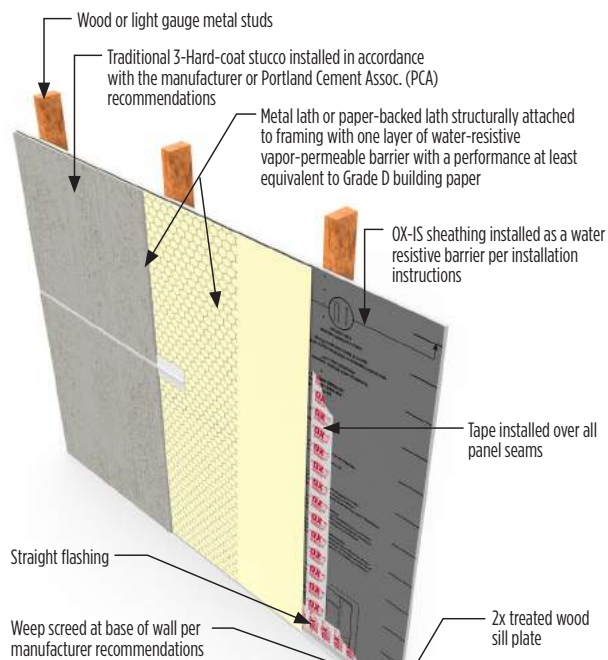

## Disclaimer

The diagrams in this guide represent a general overview for the proper exterior cladding installation. Please defer to the installation instructions of your cladding manufacturer and local code requirements to ensure best results.



# 09 | Vents and Openings Installation

## Typical Vent Installation

- Install approved OX tape in holes in OX-IS panels as shown in Detail K on a clean/dry surface
- Use flexible flashing tape on lower side of holes covering the foam panel interior
- Apply a continuous bead of sealant on top of flexible flashing tape
- Install heavy flashing on top and sides of vent and then tape top of heavy flashing with OX approved tape
- All vents and penetrations should be properly blocked per manufacturer recommendations

Detail L

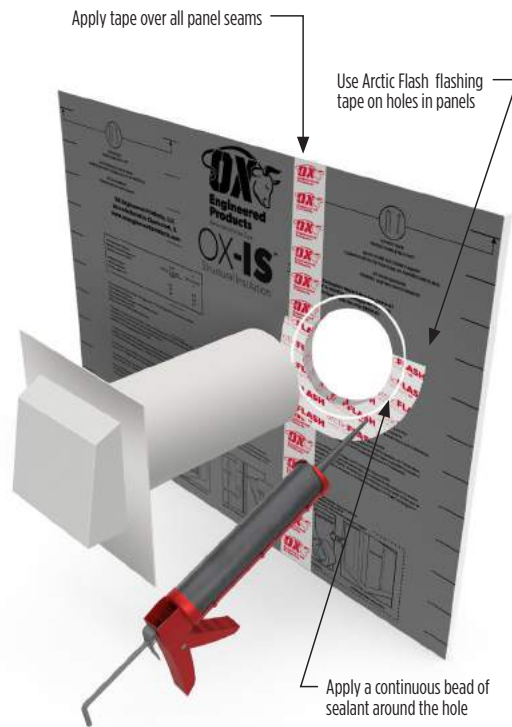

Detail M - Completed installation

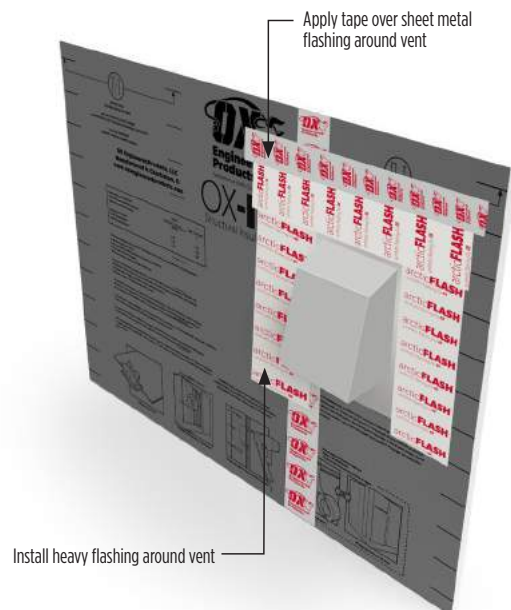

#### WARRANTY COVERAGES

Subject to the terms, limitations, and requirements set forth in this document, Ox Engineered Products, LLC, ("OX"), warrants to the original purchaser (the "Original Purchaser") of the component products comprising the OX-IS™ Structural Insulation System (the "IS System" as defined below) as follows: (a) For 30 years from the date of purchase, the IS System will be free from manufacturer's defects. Further, as of the date of purchase of the insulation component product of the IS System (if applicable), the thermal resistance of such insulation component product will not vary by more than ten percent (10%) from the R-value published in the Technical Evaluation Report ("TER") for such insulation component product which TER may be found at [www.oxep.com](http://www.oxep.com). (b) The IS System when installed strictly in accordance with OX's applicable published installation instructions in effect at the time the System is installed on the original structure, will, for a period of 30 years from the earliest date of purchase of a component product used in the IS System as installed, perform as (i) a water-resistive barrier (as defined in Section 202 of the 2018 International Building Code (IBC) and Section R202 of the 2018 International Residential Code (IRC), and (ii) an air barrier as defined in Section R202 and N1101.6 of the 2018 IRC. The IS System shall be defined to be OX-IS™ Structural Insulation (Fire Rating Class B), OX Seam and Arctic Flash Flashing Tapes, and OX ISO RED CI®. In addition to being subject to the other limitations contained in this warranty, the water and air barrier warranties are expressly contingent upon the use of only IS System component products. The use of any sheathing other than OX-IS™ Structural Insulation or OX ISO RED CI® or any seam and flashing tapes other than OX Seam and Arctic Flash Flashing Tapes shall render the air and water barrier warranties entirely inapplicable and/or null and void. OTHER THAN THE EXPRESS RIGHTS SET FORTH IN THIS WARRANTY, THE PRODUCT IS SOLD "AS IS." THE REMEDY PROVIDED IN THIS WARRANTY SHALL BE THE ORIGINAL PURCHASER'S SOLE AND EXCLUSIVE REMEDY WITH RESPECT TO THE COMPONENT PRODUCTS OF THE IS SYSTEM AND THE IS SYSTEM AS A WHOLE. THIS WARRANTY IS IN LIEU OF ALL OTHER GUARANTEES AND WARRANTIES, EXPRESS OR IMPLIED, INCLUDING THE WARRANTIES OF MERCHANTABILITY AND FITNESS FOR A PARTICULAR PURPOSE, AND SHALL NOT BE EXTENDED OR ALTERED EXCEPT BY WRITTEN AGREEMENT SIGNED BY OX AND THE ORIGINAL PURCHASER. THERE ARE NO WARRANTIES OR GUARANTEES WHICH EXTEND BEYOND THOSE SET FORTH IN THIS WARRANTY. TOTAL OX LIABILITY AND EXPENSE FOR ANY CLAIM OF NONCOMFORMITY OF ANY COMPONENT PRODUCT OF THE IS SYSTEM OR THE IS SYSTEM AS A WHOLE SHALL BE LIMITED TO THE AMOUNT RESULTING FROM THE CALCULATION PROVIDED FOR BELOW. IN NO INSTANCE SHALL OX BE RESPONSIBLE FOR INCIDENTAL OR CONSEQUENTIAL DAMAGES, NOR SHALL OX BE LIABLE FOR INCIDENTAL OR CONSEQUENTIAL DAMAGES TO ANY THIRD PARTY. THIS WARRANTY SHALL APPLY ONLY TO THE BENEFIT OF THE ORIGINAL PURCHASER OF THE COMPONENT PRODUCTS AND IS NON-TRANSFERABLE TO ANY SUBSEQUENT OWNER OF ANY STRUCTURE ON WHICH THE PRODUCTS ARE INSTALLED.

#### OTHER CONDITIONS OF WARRANTY COVERAGE

This warranty applies only to Products manufactured by OX on or after October 1, 2018. The Products are warranted to provide a weather resistant barrier only if installed with all joints covered at a minimum with 2-1/2" wide seam and flashing tape, corners taped at minimum with 4" wide Arctic Flash Flashing Tape and rough openings and wall penetrations flashed with tapes identified above.

Due to the self-healing characteristics of the Polyiso foam used in this product, it is not required to tape over any of the attachments. Tape is only required at the seams and for larger penetrations in the board.

#### The warranty will be void if any of the following conditions have occurred:

1. Prior to installation, any component product of the IS System is exposed to the elements for any length of time without protective packaging or, at a minimum, without being completely covered with a waterproof tarpaulin;
2. Prior to installation, any component product of the IS System is left on the ground rather than being raised off the ground on pallets or similar structures to prevent saturation from rain, flood waters or other sources;
3. Any component product of the IS System is not protected from excessive moisture;
4. Any component product of the IS System is left unprotected from UV exposure (sunlight without regard to cloud cover) for more than 90 days;
5. Any component product of the IS System is punctured by nail holes. The component products are not designed as a nail base for cladding. Consult the specific cladding instructions for proper cladding installation;
6. Any component product of the IS System is not utilized in strict accordance with all applicable OX specifications, recommendations and guidelines in effect at the time of purchase. These may be found on the OX website at [www.oxep.com](http://www.oxep.com).
7. Any component product of the IS System is not installed in accordance with the OX's published installation instructions, including but not limited to: a) post-installation exposure before cladding, b) protection allowing for adequate drainage, c) the use of applicable building code compliant OX branded flashing and counter flashing on all openings and penetrations, d) compliance with usual and customary local building standards, and e) compliance with all applicable building codes. Information concerning OX's specific requirements may be found on the OX website at [www.oxep.com](http://www.oxep.com). Information regarding applicable building codes and standards in your area may be obtained from your local building inspector.
8. The envelope of the structure must be maintained to prevent infiltration of water.
9. Any component product of the IS System cannot be used in an exterior exposure or in an interior space that creates an exterior environment. Any component product of the IS System may not be in direct contact with the ground or used in any application which allows for the accumulation of condensation or other free water or which subjects any component product of the IS System to a repetitive wetting condition at any time, other than normal exposure to weather during ordinary construction delays.

---

**1 This warranty is effective April 1, 2019 and supersedes all previously published versions of warranties for all Products covered by this warranty. It shall remain effective until such time as OX publishes a subsequent superseding version at which time it shall have no further effect.**

**This Warranty shall not apply and OX shall not be liable for any damages caused by:**

- 1.** Misuse, improper storage, transportation, maintenance and handling of any component product of the IS System in violation of OX recommendations or requirements;
- 2.** Structural failure or distortion caused by failure or distortion in the walls or foundation of the structure on which any component product of the IS System is installed, including settling of the building or movement of framing components;
- 3.** Any removal and reuse of any component product of the IS System;
- 4.** Physical forces such as fire, flooding, or storms, including but not limited to, hurricanes and tornadoes, war, terrorism, or civil unrest or any other act of God;
- 5.** Termites or any other product destroying organism;
- 6.** Any negligence, gross negligence or willful misconduct of Original Purchaser or any third party in connection with any component product of the IS System; or,
- 7.** Any use of any component product of the IS System other than its intended use as (for applicable Products) a thermal insulation and (for all Products) a component in an air barrier and water-resistive barrier system.
- 8.** Defective design and/or installation workmanship.

**As a condition precedent to recovery under this Warranty, Claims will only be honored if:**

- 1.** OX is notified in writing via email to warrantyclaims@oxep.com within thirty (30) days of discovery of the condition covered by the warranty and the notification includes identification of any component product of the IS System at issue, a description of the alleged nonconformity, current photographs of the alleged nonconformity, documentation of proof of purchase date of the component products; and,
- 2.** OX is given a reasonable opportunity to evaluate the problem and inspect the warranted Product prior to any alteration, change or repair undertaken by Original Purchaser or any third party. OX's liability is limited to the provisions of this Warranty, whether any claim against OX is based upon strict liability, negligence, breach of contract, breach of warranty or any other theory or cause of action. This warranty shall apply only to the Original Purchaser of the component products of the IS System and is non-transferable to any subsequent owner or claimant.

**REMEDIES**

This section provides for the sole remedy available to the Original Purchaser from OX for the non-conformance of any or all component products of the IS System as well as for any generalized IS System non-conformance. Subject to all of the conditions and limitations provided in this warranty, for IS System component products utilized to create the building envelope of a new structure not exceeding four stories in height, should OX determine through the course of its investigation at its sole discretion that the IS System is non-conforming, OX will pay for the reasonable cost of repairing and replacing (labor and materials) the actual area of wall damage caused by the non-conforming IS System component products. OX will not cover any alleged damages to interior spaces or items including any furniture or personal property items. The limitations on coverage imposed by this remedy may not apply in jurisdictions that prohibit such limitations. To qualify for this 30 year limited system warranty, the entire building envelope of the structure must be constructed exclusively using the IS System. This warranty will be null and void should any other non-IS System component be used on the building in question or should the building exceed four stories in height. The warranty coverage provided by this provision shall not exceed the lesser of (i) \$10 per square foot of damaged exterior wall area, or (ii) \$500,000.

**TESTING**

All sampling shall be conducted in accordance with sampling procedures prescribed by OX, in its sole discretion, and samples shall only be taken in the presence of an authorized OX representative. Original Purchaser agrees at his own expense to take samples of the product in accordance with OX's sampling procedures for evaluation according to industrial standards to determine the validity of any alleged nonconformity.

**MISCELLANEOUS**

OX can be contacted by mail at its offices currently located at 22260 Haggerty Road, Suite 365, Northville, Michigan 48167. All matters covered by this Warranty shall be governed by, and construed in accordance with, the laws of the State of Michigan, without regard to conflicts of law analysis. Original Purchaser agrees that jurisdiction and venue with regard to any suit brought which is related in any way to the IS System or any component product or this Warranty shall reside solely in the state and federal courts serving the county in which OX's headquarters are then located. Accordingly, in purchasing and using the products, Original Purchaser consents to the exercise of personal and subject matter jurisdiction and venue over himself and his agents and employees by such courts for said purposes. To the extent that any portion of this provision may be deemed unenforceable by a court, Original Purchaser intends that this provision shall be construed as broadly as possible to limit the adjudication of disputes arising from his purchase and use of the products to the courts serving the locality in which OX's headquarters are then located. Original Purchaser hereby waives any right to trial by jury. This Warranty contains the complete and exclusive agreement between the Original Purchaser and OX, and supersedes any and all prior, oral or written, agreements or representatives, made by or between them. All of the clauses of this Warranty are distinct and severable, and if any clause shall be deemed illegal, void, or otherwise unenforceable, it shall not affect the validity, legality, or enforceability of any other clause or portion of this Warranty.