

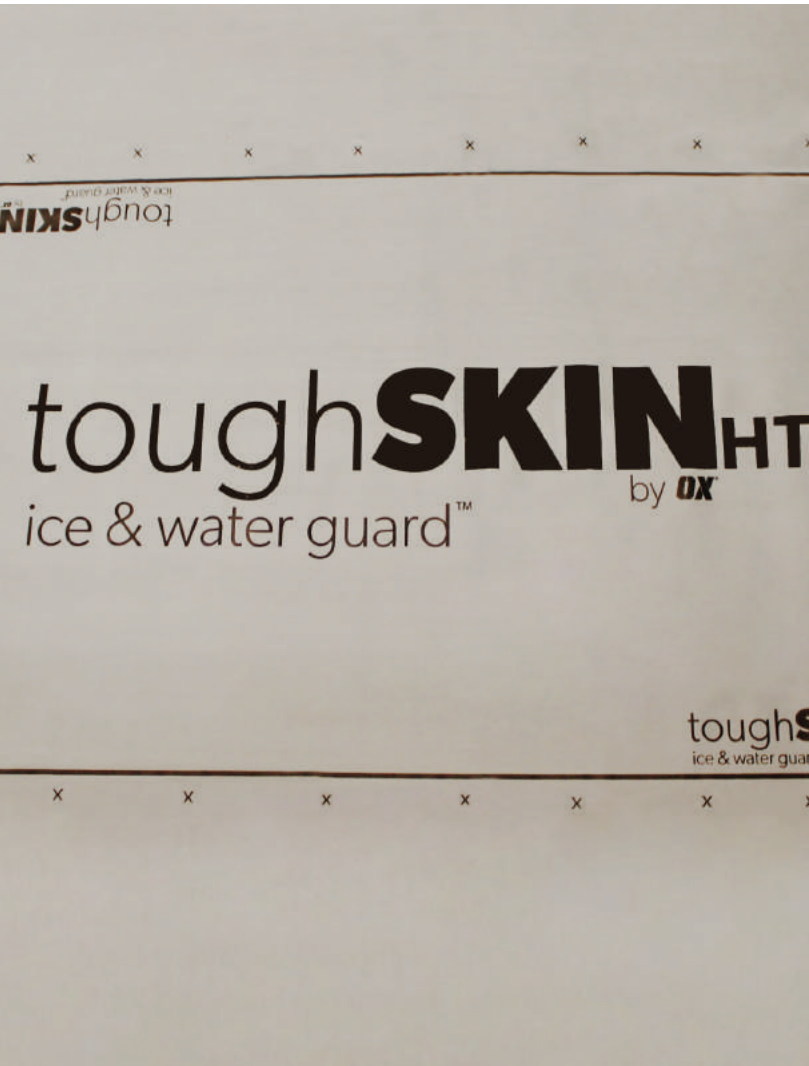

OX Engineered Products
22260 Haggerty Road Suite 365
Northville, MI 48167
p. 1.800.345.8881
f. 248.289.9955
oxep.com



toughSKIN^{HT}

ice & water guard™ by **OX**

With SlipSafe® Technology

Installation Guide

ToughSkin HT Ice & Water Guard™ is a self-adhered underlayment that consists of our ToughSkin®SlipSafe® Technology coated with a rubberized asphalt adhesive. This technology allows for a superior adhesion over a large range of temperatures, including high temperature applications such as metal roof systems. Our skid-resistant surface includes our high tensile strength ToughSkin® design while staying lighter for easier handling.

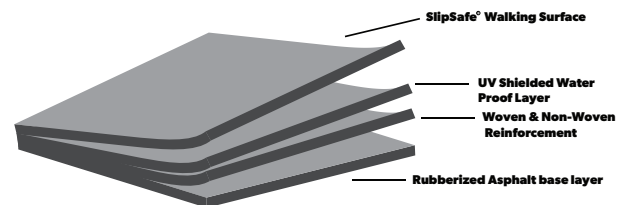

Strong Adhesion

The rubberized asphalt adhesive maintains adhesion and sealability over a large temperature range

Watertight Laps

Membrane easily forms water-tight overlaps due to the topcoat adhesion strip

SlipSafe® Technology

Self-adhered membrane has a slip resistant embossed surface for optimal traction

Environmentally Friendly

No oil leaching - no hazardous material content

CONTENTS

- | | | | |
|----|--|----|---------------------------------------|
| 02 | General Notes, Guidelines & Storage | 05 | Valleys & Dormers |
| 03 | Installation Instructions Cont. & Important Considerations | 06 | Chimney Flashings & Pipe Penetrations |
| 04 | Rakes & Eaves and Roof to Wall Transitions | | |
-

Attention:

This installation guide is intended to provide general information for the end user. The following guidelines will help you properly install ToughSkin HT Ice & Water Guard™. We encourage you to read these guidelines in order to minimize any risk of safety hazards and to prevent voiding any applicable warranties. This manual is a general installation guide and does not cover every installation situation. Customer is responsible for complying with all applicable laws, regulations, and building codes (collectively, "Laws") of the location where any products (individually, "Product" and collectively, "Products") manufactured by Ox Engineered Products, LLC ("Ox") are actually used, specially including, but not limited to, Laws regarding use and disposal of the Products by Customer.

Ox expressly disclaims all liability for the Products other than as expressly provided in the applicable warranty for the Product (the "Product Warranty") which is available from Ox at the address below. OX EXPRESSLY DISCLAIMS ANY OTHER WARRANTY EXPRESSED OR IMPLIED INCLUDING SPECIFICALLY, BUT NOT LIMITED TO, ANY WARRANTY OF MERCHANTABILITY OR FITNESS FOR A PARTICULAR PURPOSE. None of the information contained in this brochure shall act as a waiver of any patent, trademark, copyright or other intellectual property right of Ox, nor shall any such information expand any rights or remedies set forth in the applicable Product Warranty. Ox shall not be liable for compliance of the Products with any test results obtained by third parties that may be included in this brochure. Actual results may vary. Not all

Products are approved for use in all jurisdictions. The Products are not load bearing. Do not attempt to walk on them. Some Ox Products are amiable. Ox disclaims liability for damages caused by incineration of the Products. By purchasing the Products, Customer irrevocably consents that any dispute arising between Ox and Customer will be determined under Michigan law without consideration of any of law analysis and that any such dispute shall be brought only in the state or federal courts serving the locality in which Ox's headquarters are then located. By purchasing the Products, Customer expressly consents to the exercise by such courts of personal and subject matter jurisdiction and venue for such purposes.

Ox Engineered Products offices:

22260 Haggerty Road, Suite 365,
Northville, Michigan 48167.
Phone (800)345-8881

Storage:

Maintain packaging protection until using the product. If stored exposed without protective packaging, cover with a waterproof tarpaulin. Do not store directly on the ground unprotected or in standing water. Normal care should be taken to avoid excessive moisture exposure (soaking) to unpackaged product.

Safety Guidelines:

Follow all OSHA regulations and any other safety guidelines and safety practices. Use approved safety belts and/or harnesses or other fall protection equipment

02 Installation Instructions

ToughSkin HT Ice & Water Guard™ is applied when the roof deck is dry and the air, membrane and substrate temperatures are 40° F (4.4° C) or higher. At temperatures below 40° F, nailing or priming should be used to temporarily hold the membrane in place while adhesion develops.

Material must be rolled in place with a weighted roller to ensure positive contact with roof surface. Brooming is recommended as an option for steep-sloped roof conditions where use of a weighted roller is deemed unsafe. Material that does not make full contact to substrate will not bond.

ToughSkin HT Ice & Water Guard™ is designed to be covered with the primary roofing system and should not be exposed to sunlight for more than 180 days.

Substrate must be free of any moisture as it may inhibit adhesion. Prepare the roof deck by removing all loose objects, dirt, dust or debris. For re-roofing applications, remove all old materials from the roof deck in the area to be covered with ToughSkin HT Ice & Water Guard™. Replace water-damaged sheathing and sweep roof deck thoroughly.

Priming is not required on clean, dry wood, metal or most polyisocyanurate surfaces (polyiso paper/facer does require priming). Masonry and exterior gypsum boards should be primed using an appropriate primer or adhesive. Some rigid insulation boards with porous or dusty surfaces may require priming to promote initial adhesion. Priming is required on all substrates when air, membrane or substrate temperatures are below 40° F (4.4° C), contact your local sales representative for recommendations of approved products that are acceptable to use with ToughSkin HT Ice & Water Guard™. Refer to your local building codes to determine acceptable product for use in your region.

Selection of roof deck or insulation substrate and/or use of a primer or adhesive are the responsibility of the architect, specifier or roofing contractor to determine based on the roof assembly and environmental conditions.

Valleys, Hips & Ridges

Cut ToughSkin HT Ice & Water Guard™ roofing underlayment into manageable lengths. Align over the center of the valley, hip or ridge. Remove release film. Press the middle of the membrane first before working toward the edges. For open valleys, cover ToughSkin HT Ice & Water Guard™ with metal valley liners.

Eaves & Rakes

Cut ToughSkin HT Ice & Water Guard™ roofing underlayment into 10-15' pieces. Remove 2-3' of release film and align the edge of the membrane, sticky side down, so it overhangs the drip edge by 3/7" (10mm). Continue to remove release film and press as you move across the roof. Use a hand roller and/or hand pressure to press into place. For split-release film, peel half the liner off the cut length and position membrane in place. Apply firm, even pressure from the center to the outer edge. Remove the remaining half of the film and apply pressure to secure the membrane. Overlap end laps a minimum of 6". ToughSkin HT Ice & Water Guard™ should reach a point 2' past the inside of the interior wall line. Local codes may require additional courses. If additional course are required, the top lap must be at least 3".

03 Installation Instructions Continued

Drip Edges

At the rake edge, apply ToughSkin HT Ice & Water Guard™ first and place drip edge on top. At the eave, apply drip edge first and place ToughSkin HT Ice & Water Guard™ on top of the drip edge so that it overhangs drip edge 3/8" (10 mm)

For standard installation details, follow the ToughSkin HT Ice & Water Guard™ detail drawings found on page 4 of this guide. For non-standard installation instructions, contact your local Ox Engineered Products Sales Representative.

Metal Roof Underlayment

Under water-shedding metal roof systems or low-slope metal roofs with a minimum 1/2" slope, start at the low point and apply ToughSkin HT Ice & Water Guard™ over the full surface of the roof deck. Review the metal roofing manufacturer's instructions for limitations and precautions. Beginning at the eaves, apply product from the low point to the high point of the roof, running the roll horizontally.

Important Considerations

- Do not expose ToughSkin HT Ice & Water Guard™ to sunlight for longer than the recommended 180 days.
- ToughSkin HT Ice & Water Guard™ should not be folded over the roof edge unless protected by a gutter or other flashing material.
- The primary roof system must be ventilated to prevent excessive moisture build up in the interior structure.
- Use caution during the installation of the membrane as it may become slippery when wet or covered with frost.
- ToughSkin HT Ice & Water Guard™ is not to be used in contact with flexible PVC material.
- For metal roof installations, be sure to follow the metal manufacturer's recommended installation guidelines for underlayments.
- ToughSkin HT Ice & Water Guard™ rolls should be stored under cover and in areas where the temperature is between 40° and 100°F (4.4° and 38°C). **Do not double stack pallets.**
- ToughSkin HT Ice & Water Guard™ products installed at 100% coverage will create an air and vapor barrier on the roof deck.
- ToughSkin HT Ice & Water Guard™ is not approved for use in foam set tile applications.
- ToughSkin HT Ice & Water Guard™ is not to be used in contact with flexible PVC material.
- ToughSkin HT Ice & Water Guard™ should not be used in contact with flexible PVC or PVC trim materials.

04 Installation Details

Rakes & Eaves

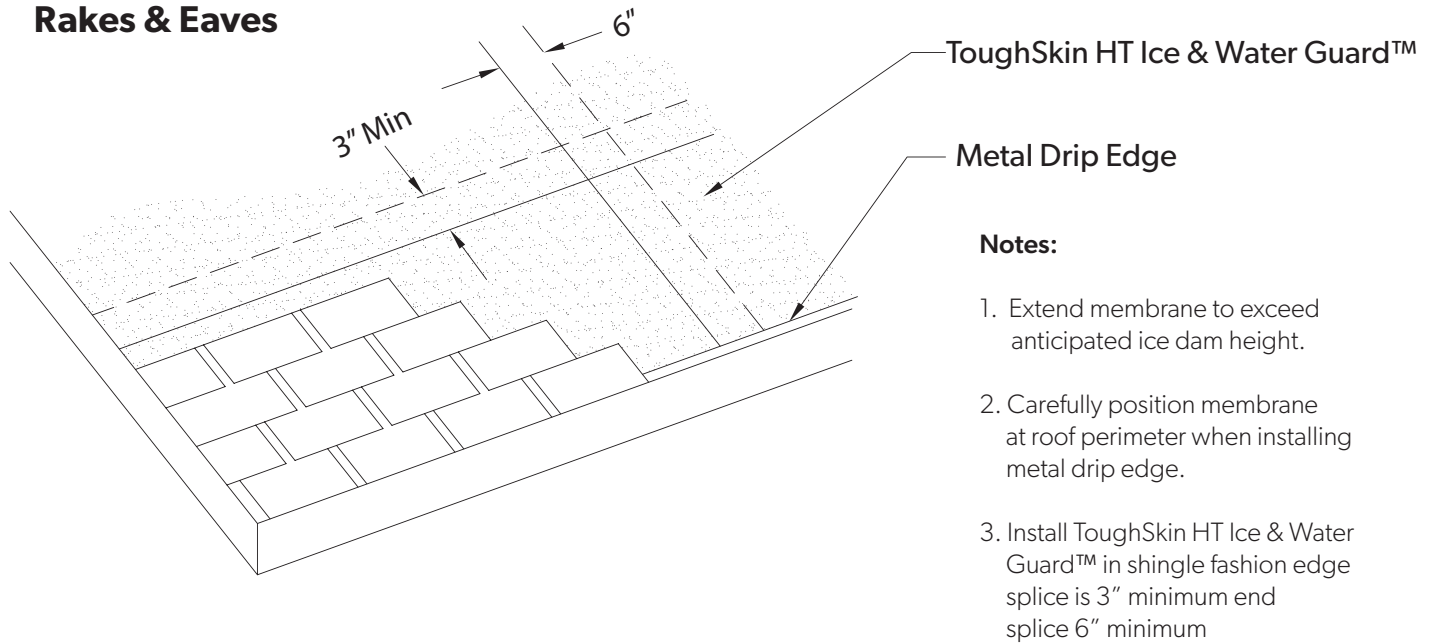

Roof to Wall Transitions

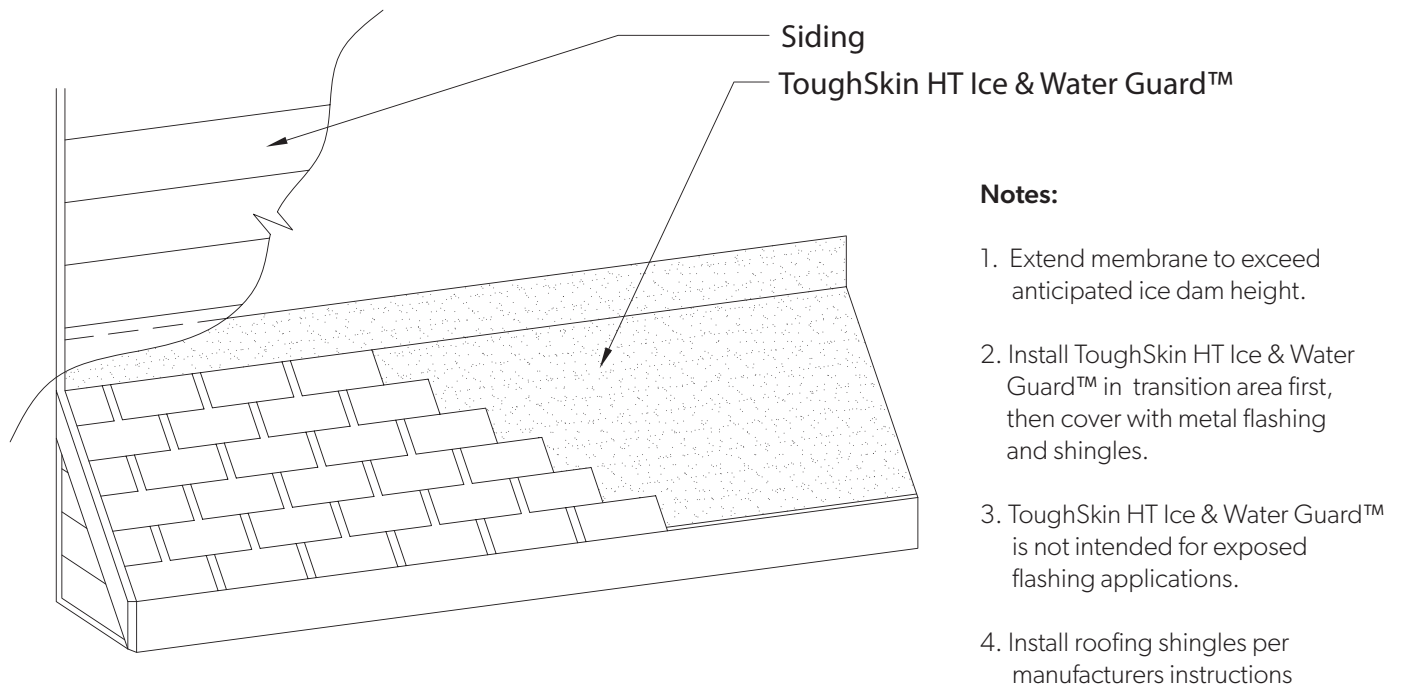

05 Installation Details Continued

Valleys

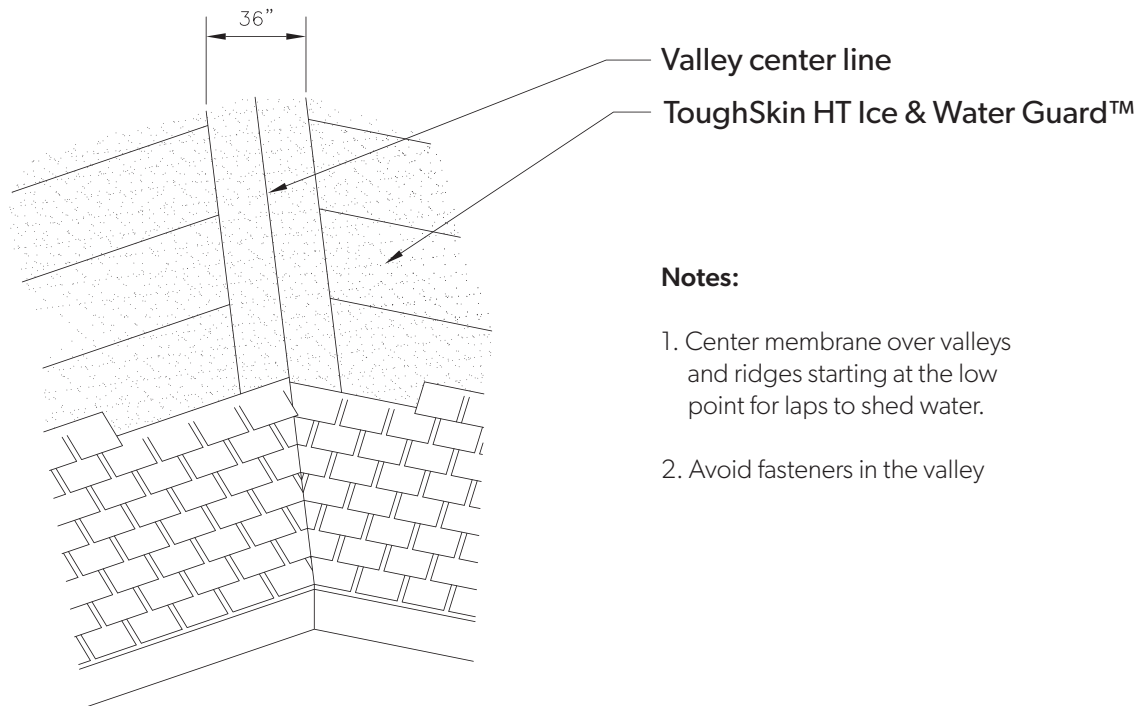

Dormers

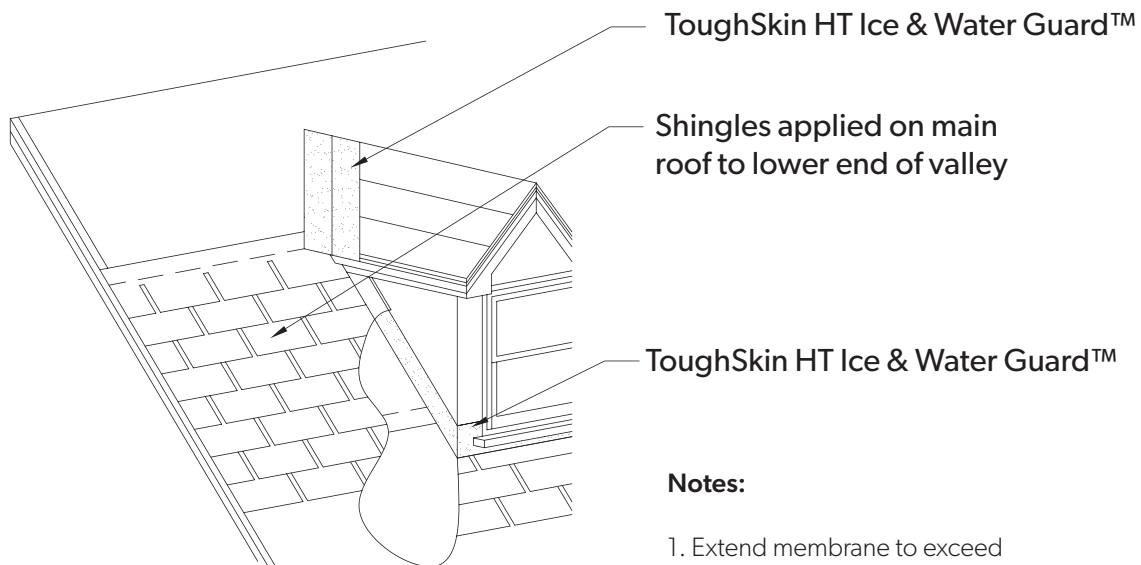

06 Installation Details Continued

Valleys

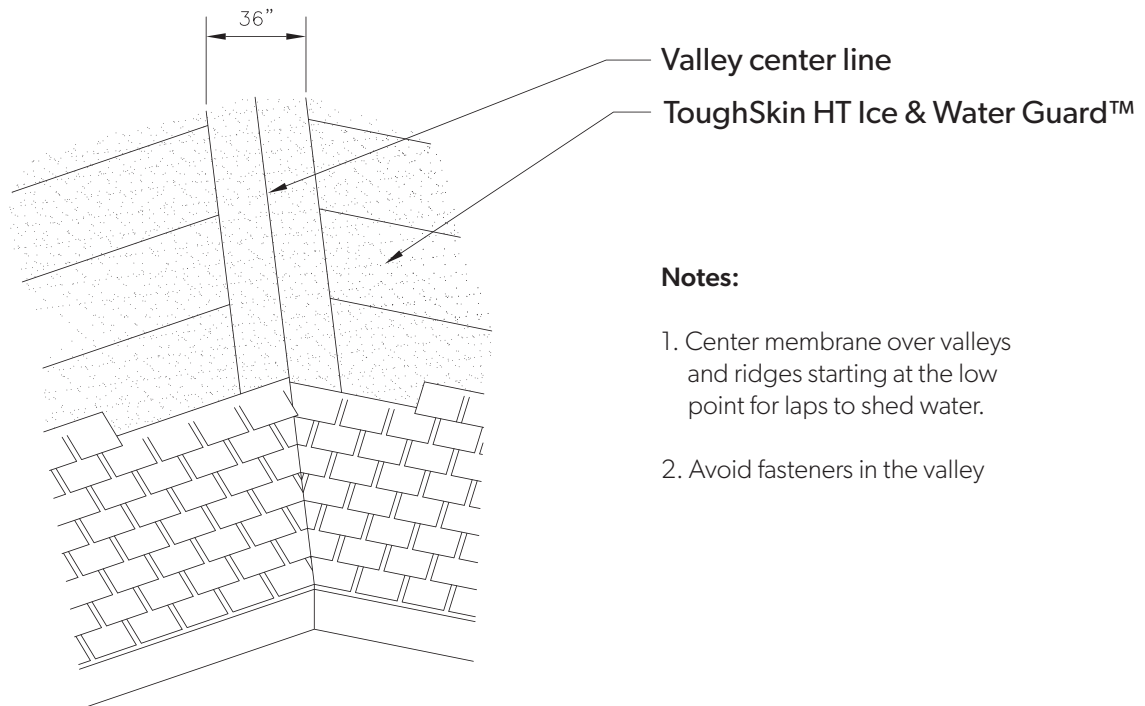

Dormers

