

Installing HomeGuard[®] Housewrap and Titan[®] Drainage Wrap by Ox

HomeGuard by Ox[®] provides this guide to assist builders by demonstrating an efficient and effective method for installing HomeGuard's housewraps in residential and light commercial buildings. The back of this document has details integrating housewrap with window flashing. Compliance with the local building code and proper installation are critical in reducing potential water intrusion. It is the responsibility of the architect or builder to ensure that these standards are met.

Homeguard[®] housewraps are available in a variety of widths and lengths to meet your needs. The following HomeGuard[®] products are needed for a quality installation:

- HomeGuard[®] Housewrap
- Titan[®] Drainage Wrap
- HomeGuard[®] Seam Tape
- Ox Butyl Flashing[®] 4, 6, 9, 12" x 75' rolls
- HomeGuard Polymer Sealant[®] (Meets AAMA Standards)

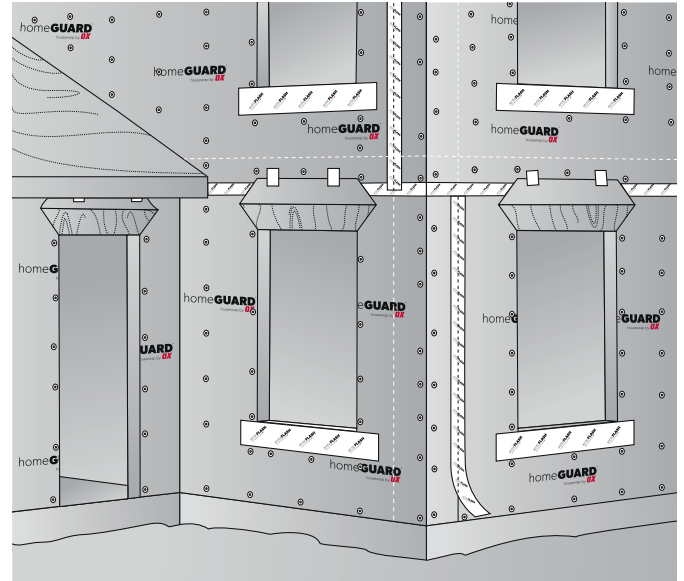

*** Asphalt flashing products should not be used with Titan Drainage Wrap**

1 INSTALLING HOUSEWRAP

Install housewrap over an approved exterior sheathing. Starting at the bottom of one end of the wall, place the housewrap roll horizontally and roll out the first course evenly, covering rough window and door openings. When starting at a corner, overlap by a minimum of 12". Attach the membrane so that it is tight and flat. Fasten housewrap securely to the exterior wall with appropriate fasteners. **(Step 2)**

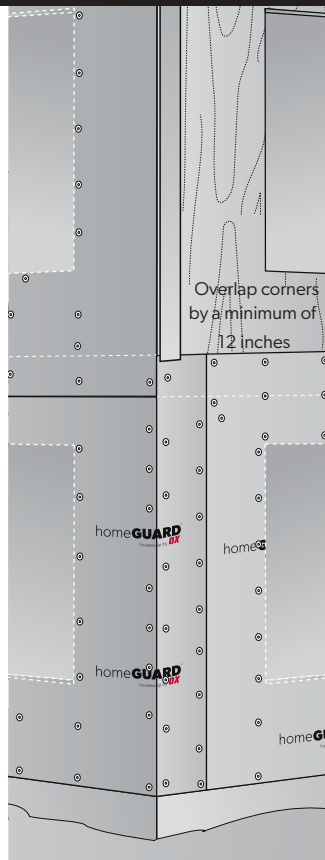

OX Engineered Products
22260 Haggerty Road Suite 365
Northville, MI 48167
p. 1.800.345.8881
f. 248.289.9955
oxep.com

2 FASTENING

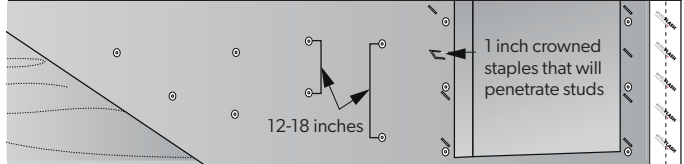

HomeGuard[®] recommends using a minimum 1" plastic cap fasteners (minimum 15/16" crown staples that penetrate the studs are acceptable) to attach housewrap so that it is taut and flat. The proper spacing for these fasteners is 12" to 18" on center. Guide marks have been printed every 8" to help locate studs.

3 OVERLAP AND TAPE SEAM

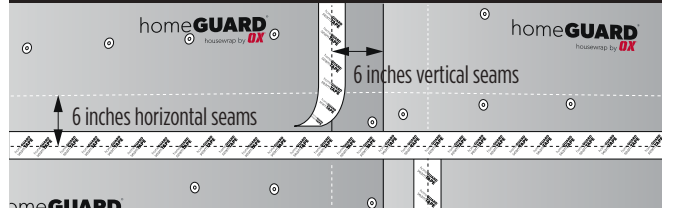

At vertical and horizontal seams, apply a minimum of 6" vertical overlap. When going around corners, make sure housewrap is pulled tightly and properly fastened. Any succeeding course should be placed horizontally over the lower course in a weather-board fashion with a minimum horizontal overlap of 6". Use **HomeGuard[®] Seam Tape** to seal all seams.

We recommend using a 4"x3" squeegee, J-Roller or Tape Gun when applying HomeGuard Seam Tape for best adhesion to the HomeGuard Housewrap or Titan Drainage Wrap.

Housewrap and Window Flashing

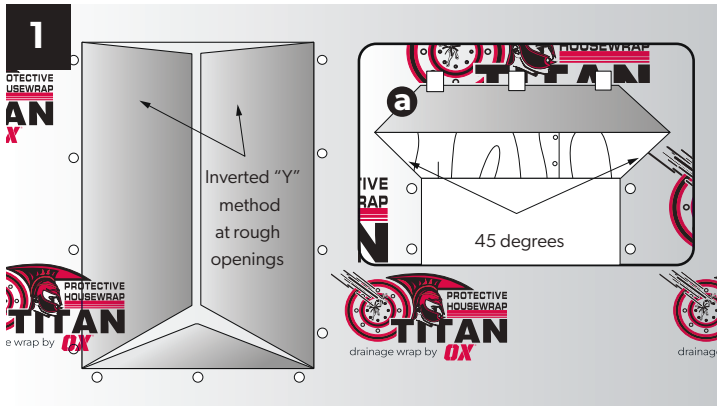

At the rough opening, cut housewrap in an inverted "Y" fashion, and then fasten with the methods described in **Step 2**. To allow for head flashing integration, make a 45° cut in housewrap as shown above in detail **a**. Ensure that any protrusions in the wall assembly including windows, doors, vents, hose bibs and electrical boxes are flashed and integrated properly into housewrap.

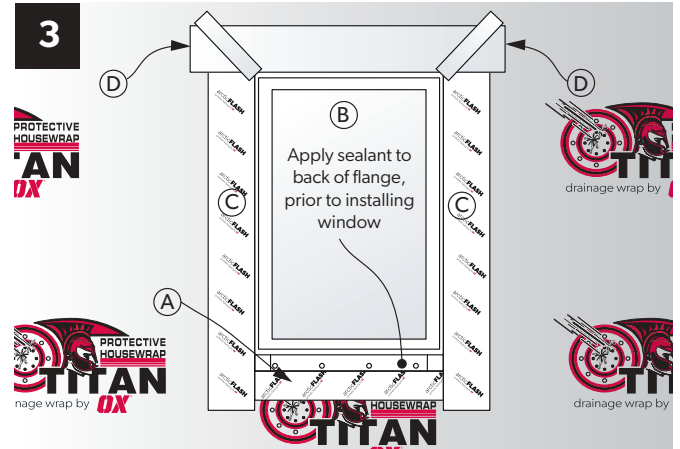
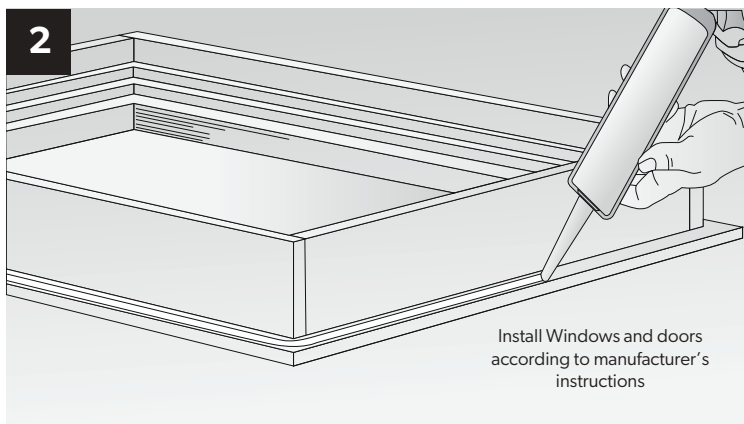

To integrate windows and doors properly into housewrap, follow these steps; **A)** Install the window flashing on the sill flush with the rough opening. **B)** Apply 3/8" bead of **HomeGuard[®] Polymer Sealant** to the back side of the window flange and secure the window in place. **C)** After the window is set, apply flashing to both jambs. **D)** Install the head flashing and re-integrate the head flap with **HomeGuard[®] Seam Tape**. **We recommend using a 4"x3" squeegee or J-Roller when applying the Flashing Tape for best adhesion to the HomeGuard Housewrap or Titan Drainage Wrap.**

WHEN HOUSEWRAP IS INSTALLED BEFORE THE WINDOW:

Use the following guide
Method A1 (self adhesive)

WHEN HOUSEWRAP IS INSTALLED AFTER THE WINDOW:

Use Method A (self adhesive)

HOUSEWRAP AND SPECIALTY WINDOWS:

Use one of the following guides that apply. Window and Door Flashing (Installing Wood Windows and Doors with integral brick mold) Arched Window Flashing